

## Módulo recto 1000 mm

Linear element 1000 mm

Elément droit 1000 mm

∅	Referencia	€/Ud	L	
80	PVT080		1000	4
100	PVT100		1000	4

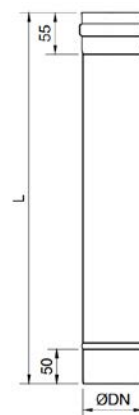

## Módulo recto 500 mm

Linear element 500 mm

Elément droit 500 mm

∅	Referencia	€/Ud	L	
80	PVT08050		500	4
100	PVT10050		500	4

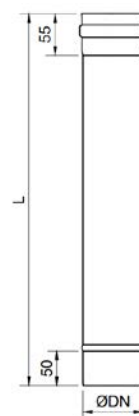

## Módulo recto 250 mm

Linear element 250 mm

Elément droit 250 mm

∅	Referencia	€/Ud	L	
80	PVT08025		250	4
100	PVT10025		250	4

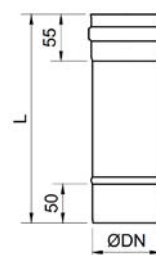

## Módulo recto 150 mm

Linear element 150 mm

Elément droit 150 mm

∅	Referencia	€/Ud	L	
80	PVT08015		150	8
100	PVT10015		150	4

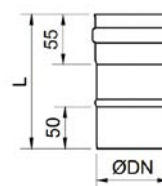

# EXOPELLET

## Módulo extensible 940 mm

940 mm telescopic element  
Elément télescopique 940 mm

∅	Referencia	€/Ud	L	
80	PVTL080		570 - 940	1
100	PVTL100		570 - 940	1

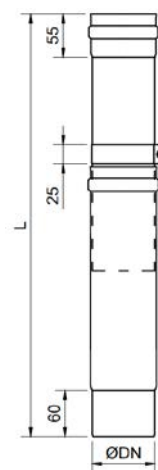

## Módulo extensible 540 mm

540 mm telescopic element  
Elément télescopique 540 mm

∅	Referencia	€/Ud	L	
80	PVTL08050		390 - 540	1
100	PVTL10050		390 - 540	1

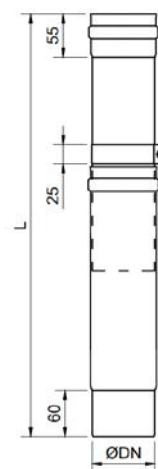

## Ampliación

Augmentation  
Augmentation

∅	Referencia	€/Ud	∅ M	∅ H	L	
80 - 100	PVA080100		80	100	155	4

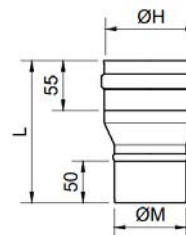

## Reducción

Reducer  
Réduction

∅	Referencia	€/Ud	∅ M	∅ H	L	
80 - 100	PVR100080		100	80	152	4

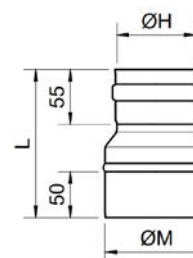

## Codo a 30°

30° elbow

Coude 30°

∅	Referencia	€/Ud	A	B	
80	PVC08030		170	45	4
100	PVC10030		175	50	4

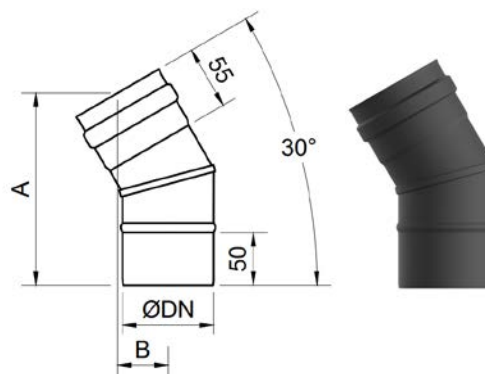

## Codo a 45°

45° elbow

Coude 45°

∅	Referencia	€/Ud	A	B	
80	PVC08045		160	68	4
100	PVC10045		163	70	4

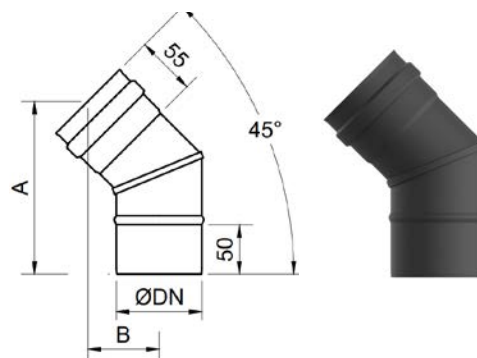

## Codo a 90°

90° elbow

Coude 90°

∅	Referencia	€/Ud	A	B	
80	PVC08090		125	125	4
100	PVC10090		145	135	4

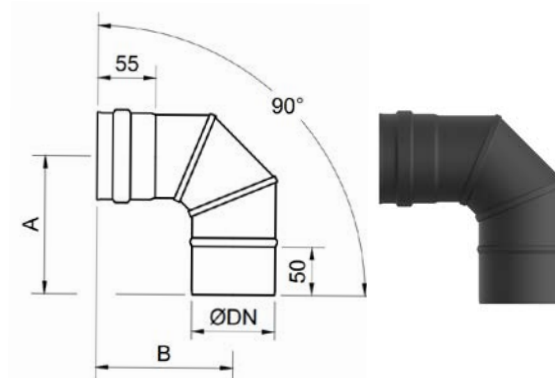

## Codo a 90° con inspección

90° bend with registration

Coude 90° avec enregistrement

∅	Referencia	€/Ud	A	B	
80	PVC080R		140	150	4
100	PVC100R		160	150	4

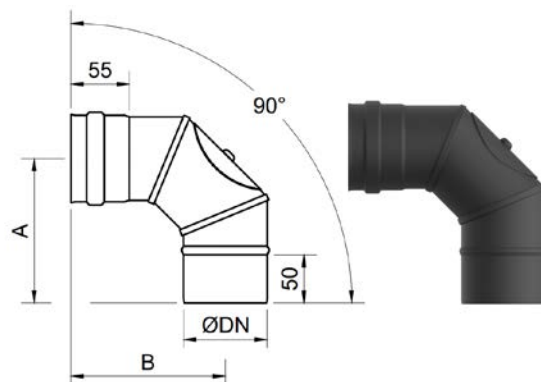

### Te a 90° con colector

90° T pipe fitting and blind cap  
Raccord á T 90° tampon

Ø	Referencia	€/Ud	A	B	C	D	
80	PVTE08090T		180	115	80	40	3
100	PVTE10090T		245	120	125	60	3

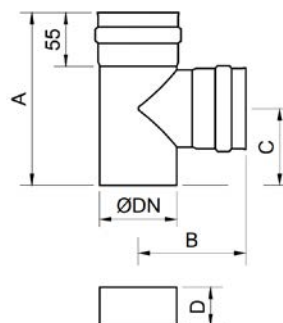

### Te a 90° con injerto 80 mm.

90° T pipe fitting female-male  
Raccord á T 90°

Ø1	Referencia	€/Ud	Ø2	A	B	C	
100	PVTE10008090		80	245	120	117	3

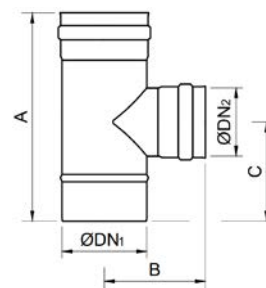

### Estabilizador de tiro

Draught stabilizer / Régulateur de tirage

Ø	Referencia	€/Ud	L	
80	ETIRO080		95	1



### Colector

Blind cap  
Tampon

Ø	Referencia	€/Ud	L	
80	PVTA080		40	1
100	PVTA100		60	1

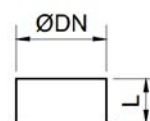

## Colector silicona

Silicon plug  
Bouchon silicone

∅	Referencia	€/Ud	L	
80	PVTA080S		45	1

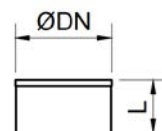

## Manguito unión M-M

Muff male-male  
Manchon mâle-mâle

∅	Referencia	€/Ud	L	
80	PVM080		105	8
100	PVM100		103	4

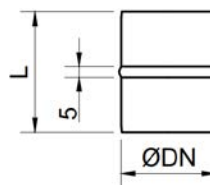

## Manguito unión H-H

Muff female-female  
Manchon femelle-femelle

∅	Referencia	€/Ud	L	
80	PVMH080		136	8
100	PVMH100		136	4

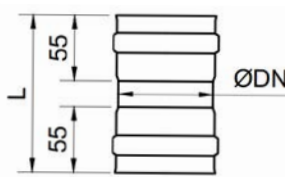

## Junta de silicona

Silicon gasket  
Joint silicone

∅	Referencia	€/Ud	
80	PVJS080		1
100	PVJS100		1



## Plafón

Ring  
Rosace

∅	Referencia	€/Ud	∅A	
80	PV080		152	10
100	PV100		190	10

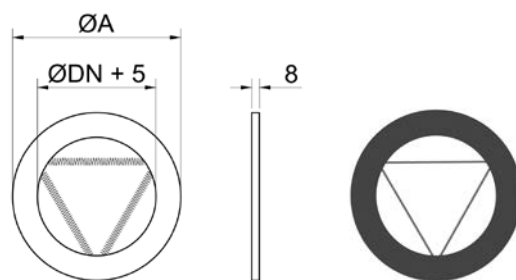

## Rosetón de silicona

Silicon rosette  
Rosette silicone

∅	Referencia	€/Ud	
80	PVJSROSET080		10
100	PVJSROSET100		10

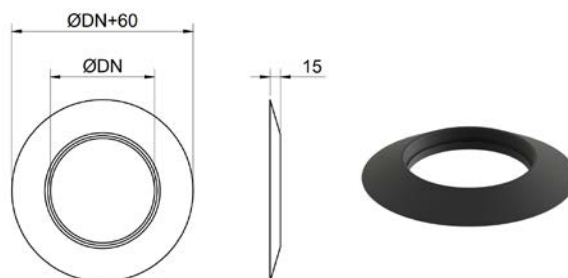

## Soporte mural de atornillar

Support pipe clip  
Régulateur de tirage

∅	Referencia	€/Ud	A	
80	ABVMA080		85	1
100	ABVMA100		90	1

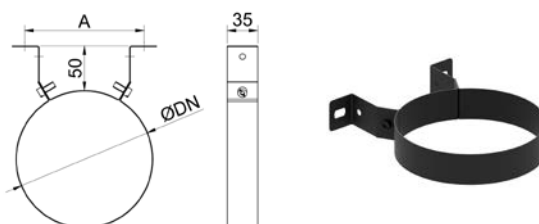

## Soporte M8

Support pipe clip  
Régulateur de tirage

∅	Referencia	€/Ud	
80	ABVM8080		1
100	ABVM8100		1

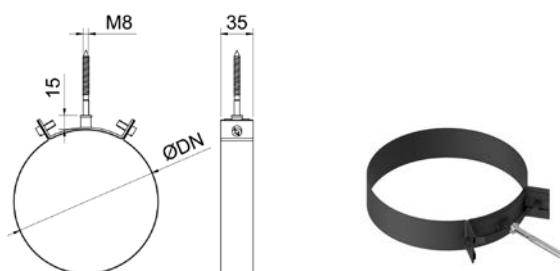

## Abrazadera de unión\*

Lockin clamp  
Bride de securité

∅	Referencia	€/Ud	
80	ABVU080	1	1
100	ABVU100	1	1

\* lacado

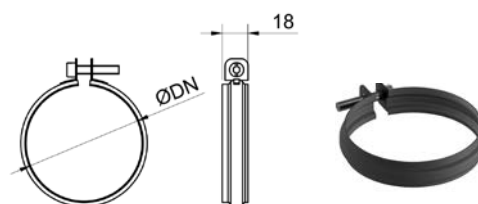

## Terminal chino\*

Rain ending part  
Chapeau chinois

∅	Referencia	€/Ud	A	∅B	
80	PVTERC080	180	180	183	1
100	PVTERC100	190	190	205	1

\* lacado

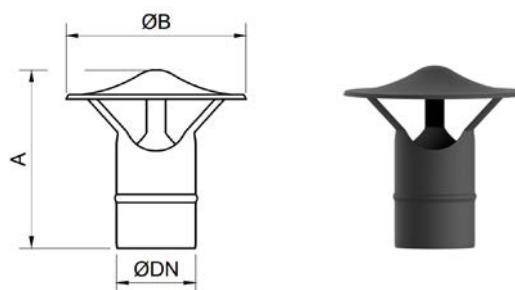

## Terminal antirrevocante\*

Windproof ending part  
Chapeau anti-vent

∅	Referencia	€/Ud	A	∅B	
80	PVTERA080	270	270	183	1
100	PVTERA100	260	260	202	1

\* lacado

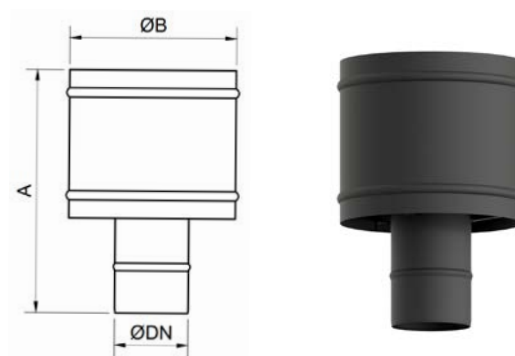

## Terminal antilluvia horizontal\*

Rainproof ending part  
Capuchon anti-pluie

∅	Referencia	€/Ud	L	
80	PVTERHA080	195	195	1
100	PVTERHA100	195	195	1

\* lacado

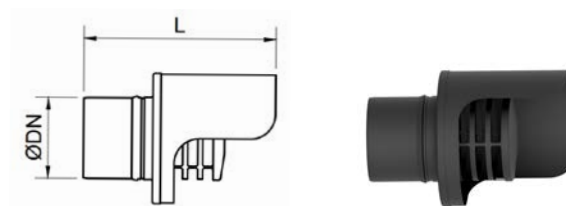

# EXOPELLET

## Terminal descarga horizontal\*

Discharge grate  
Capuchon dégagement

Ø	Referencia	€/Ud	L	
80	PVTERD080		145	1
100	PVTERD100		145	1

\* lacado

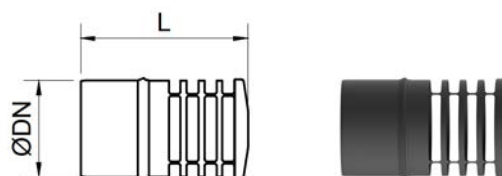

## Terminal de lamas\*

Lamellar ending part  
Chapeau lamellaire

Ø	Referencia	€/Ud	A	ØB	
80	PVTERL080		155	162	1
100	PVTERL100		155	162	1

\* lacado

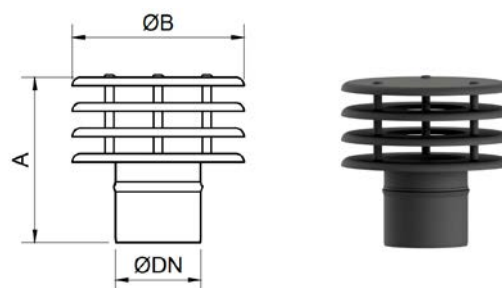

## Spray reparador

Repair spray / Spray de réparation

Referencia	€/Ud	
SPSENOTHERM		1

