

Módulo recto 1000 mm

Linear element 1000 mm / Élément droit 1000 mm

Ø	EXOINOX SW 304		EXOINOX SW 316L		L	
	Referencia	€/Ud	Referencia	€/Ud		
120	TI120	39,31 €			1000	6
130			TI130316		1000	6
150	TI150	47,85 €	TI150316		1000	6
180			TI180316		1000	4
200	TI200	65,71 €	TI200316		1000	4
250			TI250316		1000	2
300			TI300316		1000	1

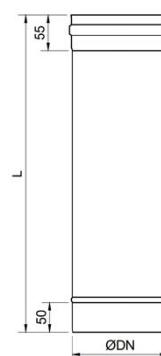

Módulo recto 500 mm

Linear element 500 mm / Élément droit 500 mm

Ø	EXOINOX SW 304		EXOINOX SW 316L		L	
	Referencia	€/Ud	Referencia	€/Ud		
130			TI13050316		500	4
150			TI15050316		500	4
180			TI18050316		500	2
200			TI20050316		500	2
250			TI25050316		500	2
300			TI30050316		500	1

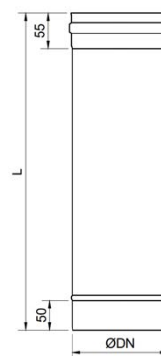

Módulo extensible 940 mm

940 mm telescopic element / Élément télescopique 940 mm

Ø	EXOINOX SW 304		EXOINOX SW 316L		L	
	Referencia	€/Ud	Referencia	€/Ud		
120			TTI120316		560 - 940	1
130			TTI130316		560 - 940	1
150			TTI150316		560 - 940	1
180			TTI180316		560 - 940	1
200			TTI200316		560 - 940	1
250			TTI250316		560 - 940	1
300			TTI300316		560 - 940	1

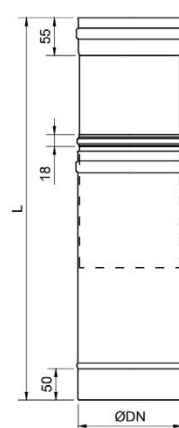

Módulo inicio anticondensación

Anti-condensation start module / Module de démarrage anti-condensation

Ø	EXOINOX SW 304		EXOINOX SW 316L		L	
	Referencia	€/Ud	Referencia	€/Ud		
120	ANTI120	43,81 €			140	1
130			ANTI130		140	1
150			ANTI150		140	1
180			ANTI180		140	1
200			ANTI200		140	1
250			ANTI250		140	1
300			ANTI300		140	1

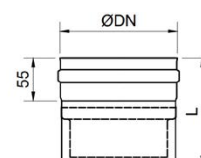

EXOINOX SW

Codo a 30°

30° elbow / Coude 30°

ø	EXOINOX SW 304		EXOINOX SW 316L		A	B	
	Referencia	€/Ud	Referencia	€/Ud			
120	CIS12030	28,91 €			175	40	4
130			CIS13030316		175	40	4
150	CIS15030	33,95 €	CIS15030316		190	45	4
180			CIS18030316		185	50	2
200	CIS20030	43,15 €	CIS20030316		205	40	2
250			CIS25030316		200	45	1
300			CIS30030316		225	60	1

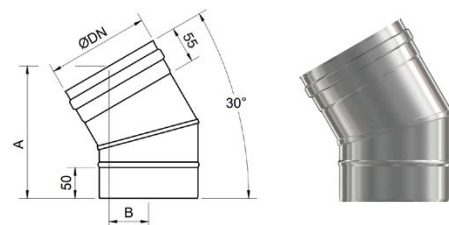

Codo a 45°

45° elbow / Coude 45°

ø	EXOINOX SW 304		EXOINOX SW 316L		A	B	
	Referencia	€/Ud	Referencia	€/Ud			
120	CIS12045	26,02 €			180	65	4
130			CIS13045316		190	65	4
150	CIS15045	30,44 €	CIS15045316		190	75	4
180			CIS18045316		195	75	2
200	CIS20045	43,15 €	CIS20045316		220	65	2
250			CIS25045316		225	85	1
300			CIS30045316		250	95	1

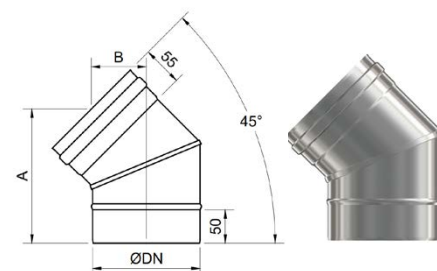

Codo a 60°

60° elbow / Coude 60°

ø	EXOINOX SW 304		EXOINOX SW 316L		A	B	
	Referencia	€/Ud	Referencia	€/Ud			
120	CIS12060	39,52 €			190	95	4
130			CIS13060316		190	95	4
150	CIS15060	45,83 €	CIS15060316		205	105	4
180			CIS18060316		225	105	2
200	CIS20060	65,58 €	CIS20060316		245	110	1
250			CIS25060316		260	135	1
300			CIS30060316		270	165	1

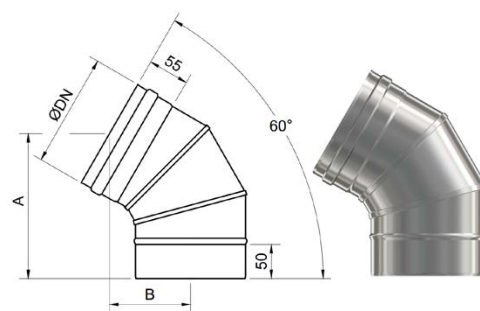

Codo a 90°

90° elbow / Coude 90°

ø	EXOINOX SW 304		EXOINOX SW 316L		A	B	
	Referencia	€/Ud	Referencia	€/Ud			
120	CIS12090	39,52 €			155	150	4
130			CIS13090316		160	155	4
150	CIS15090	45,83 €	CIS15090316		175	175	4
180			CIS18090316		180	175	2
200	CIS20090	65,58 €	CIS20090316		205	205	1
250			CIS25090316		235	230	1
300			CIS30090316		265	275	1

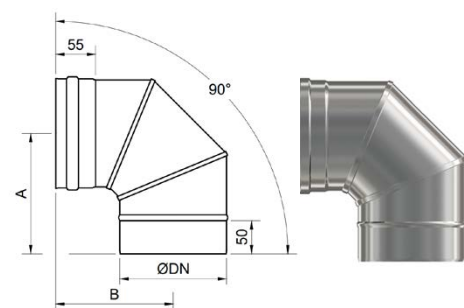

Te a 90°

90° T pipe fitting / Raccord á T 90°

Ø	EXOINOX SW 304		EXOINOX SW 316L		A	B	C	
	Referencia	€/Ud	Referencia	€/Ud				
120	TEI12090	60,17 €			255	135	135	1
130			TEI13090316		320	175	160	1
150			TEI15090316		330	175	160	1
180			TEI18090316		375	185	190	1
200			TEI20090316		400	210	200	1
250			TEI25090316		422	200	205	1
300			TEI30090316		480	230	235	1

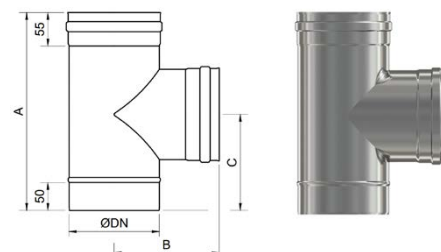

Colector

Blind cap / Tampon

Ø	EXOINOX SW 304		EXOINOX SW 316L		L	
	Referencia	€/Ud	Referencia	€/Ud		
120	TAI120	19,15 €			65	1
130			TAI130316		65	1
150			TAI150316		65	1
180			TAI180316		65	1
200			TAI200316		65	1
250			TAI250316		65	1
300			TAI300316		65	1

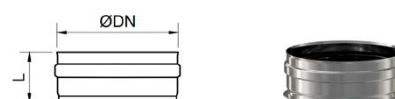

Colector con desagüe

Blind cap with drain / Tampon avec drain

Ø	EXOINOX SW 304		EXOINOX SW 316L		L	
	Referencia	€/Ud	Referencia	€/Ud		
130			TAIR130316		65	1
150			TAIR150316		65	1
180			TAIR180316		65	1
200			TAIR200316		65	1
250			TAIR250316		65	1
300			TAIR300316		65	1

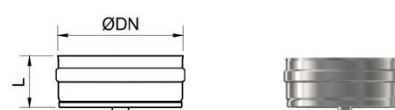

Estabilizador de tiro

Draught stabilizer / Régulateur de tirage

Ø	EXOINOX SW 304		EXOINOX SW 316L		L	
	Referencia	€/Ud	Referencia	€/Ud		
150	ETIRO150	222,90 €			95	1



EXOINOX SW

Reducción

Reducer / Réduction

Ø	EXOINOX SW 304		EXOINOX SW 316L		Ø M	Ø H	L	
	Referencia	€/Ud	Referencia	€/Ud				
130 - 120			RI130120316		130	120	190	1
150 - 120			RI150120316		150	120	195	1
150 - 130			RI150130316		150	130	180	1
180 - 150			RI180150316		180	150	200	1
200 - 150			RI200150316		200	150	235	1
200 - 180			RI200180316		200	180	195	1
250 - 200			RI250200316		250	200	250	1
300 - 200			RI300200316		300	200	300	1
300 - 250			RI300250316		300	250	225	1

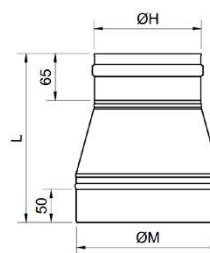

Ampliación

Augmentation / Augmentation

Ø	EXOINOX SW 304		EXOINOX SW 316L		Ø M	Ø H	L	
	Referencia	€/Ud	Referencia	€/Ud				
120 - 130			AIE120130316		120	130	180	1
120 - 150			AIE120150316		120	150	190	1
130 - 150			AIE130150316		130	150	180	1
150 - 180			AIE150180316		150	180	200	1
150 - 200			AIE150200316		150	200	230	1
180 - 200			AIE180200316		180	200	186	1
200 - 250			AIE200250316		200	250	225	1
200 - 300			AIE200300316		200	300	295	1
250 - 300			AIE250300316		250	300	250	1

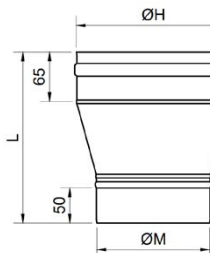

Manguito unión M-M

Muff male-male / Manchon mâle-mâle

Ø	EXOINOX SW 304		EXOINOX SW 316L		L	
	Referencia	€/Ud	Referencia	€/Ud		
120	MI120	20,18 €			105	1
130			MI130316		105	1
150			MI150316		105	1
180			MI180316		105	1
200			MI200316		105	1
250			MI250316		105	1
300			MI300316		105	1

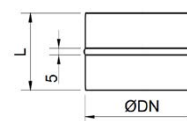

Manguito unión H-H

Muff female-female / Manchon femelle-femelle

Ø	EXOINOX SW 304		EXOINOX SW 316L		L	
	Referencia	€/Ud	Referencia	€/Ud		
120	MIH120	24,29 €			138	1
130			MIH130316		138	1
150			MIH150316		138	1
180			MIH180316		138	1
200			MIH200316		138	1
250			MIH250316		138	1
300			MIH300316		138	1

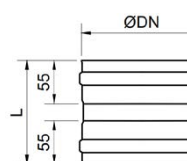

Collarín antilluvia

Collar / Colerete de solin

Ø	EXOINOX SW 304		EXOINOX SW 316L		L	ØA	
	Referencia	€/Ud	Referencia	€/Ud			
120	COA120	43,57 €			150	250	1
130	COA130	46,13 €			150	255	1
150	COA150	47,53 €			145	275	1
180	COA180	51,85 €			140	315	1
200	COA200	57,41 €			145	335	1
250	COA250	73,04 €			145	385	1
300	COA300	86,44 €			145	435	1

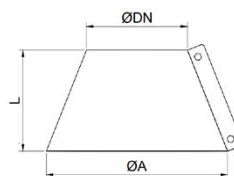

Plafón

Ring / Rosace

Ø	EXOINOX SW 304		EXOINOX SW 316L		ØA	
	Referencia	€/Ud	Referencia	€/Ud		
120	PI120	40,63 €			193	10
150	PI150	38,62 €			220	10
200	PI200	43,88 €			285	10

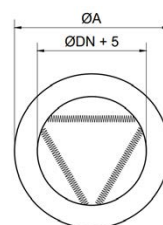

Rosetón silicona

Silicon rosette / Rosette silicone

Ø	EXOINOX SW 304		EXOINOX SW 316L		
	Referencia	€/Ud	Referencia	€/Ud	
120	ROSB120	31,04 €			1
130	ROSB130	33,29 €			1
150	ROSB150	37,71 €			1

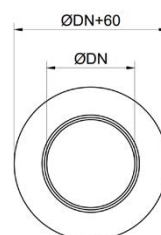

Embellecedor plano

Flat bezel / Lunette plate

Ø	EXOINOX SW 304		EXOINOX SW 316L		
	Referencia	€/Ud	Referencia	€/Ud	
130	PPI130	40,26 €			1
150	PPI150	45,40 €			1
180	PPI180	48,51 €			1
200	PPI200	51,85 €			1
250	PPI250	51,85 €			1
300	PPI300	58,86 €			1

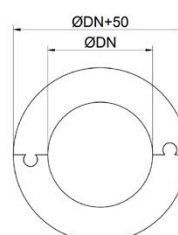

SopORTE mural de atornillar

Support pipe clip / Collier soutien tuyaux

Ø	EXOINOX SW 304		EXOINOX SW 316L		A	
	Referencia	€/Ud	Referencia	€/Ud		
120	ABIMA120				120	1
130	ABIMA130				130	1
150	ABIMA150				125	1
180	ABIMA180				160	1
200	ABIMA200				160	1
250	ABIMA250				200	1
300	ABIMA300				195	1

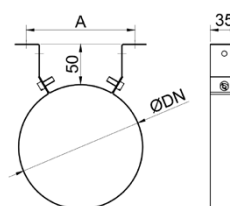

SopORTE M-8

Support pipe clip / Collier soutien tuyaux

Ø	EXOINOX SW 304		EXOINOX SW 316L		
	Referencia	€/Ud	Referencia	€/Ud	
120	ABIM8120				1
130	ABIM8130				1
150	ABIM8150				1
180	ABIM8180				1
200	ABIM8200				1
250	ABIM8250				1
300	ABIM8300				1

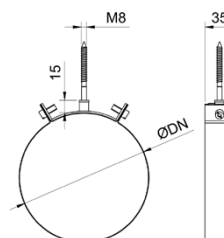

Abrazadera de unión

Lockin clamp / Bride de securité

Ø	EXOINOX SW 304		EXOINOX SW 316L		
	Referencia	€/Ud	Referencia	€/Ud	
120	ABIU120				1
130	ABIU130				1
150	ABIU150				1
180	ABIU180				1
200	ABIU200				1
250	ABIU250				1
300	ABIU300				1

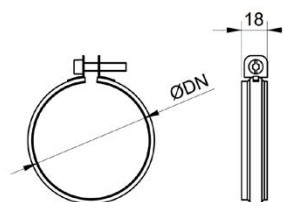

Abrazadera de vientos

Lockin clamp / Bride de securité

Ø	EXOINOX SW 304		EXOINOX SW 316L		ØA	
	Referencia	€/Ud	Referencia	€/Ud		
120	ABIV120				157	1
130	ABIV130				167	1
150	ABIV150				187	1
180	ABIV180				217	1
200	ABIV200				237	1
250	ABIV250				287	1
300	ABIV300				337	1

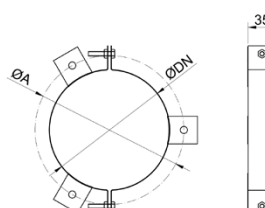

Soporte forjado

Joist support / Support au toit

Ø	EXOINOX SW 304		EXOINOX SW 316L		L	A	
	Referencia	€/Ud	Referencia	€/Ud			
130	SFI130				530	410	1
150	SFI150				550	430	1
180	SFI180				580	460	1
200	SFI200				600	480	1
250	SFI250				650	530	1
300	SFI300				700	580	1

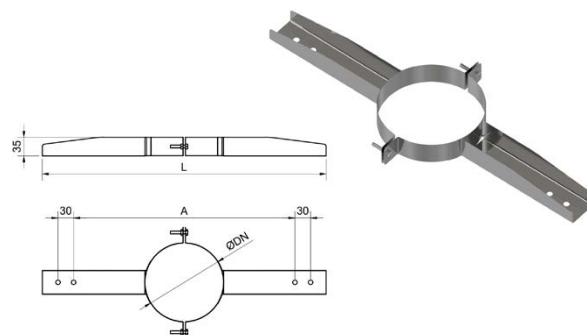

Terminal chino

Rain ending parts / Chapeau chinois

Ø	EXOINOX SW 304		EXOINOX SW 316L		A	ØB	
	Referencia	€/Ud	Referencia	€/Ud			
120	SI120				220	250	1
130	SI130				230	250	1
150	SI150				225	300	1
180	SI180				290	330	1
200	SI200				290	380	1
250	SI250				340	450	1
300	SI300				370	520	1

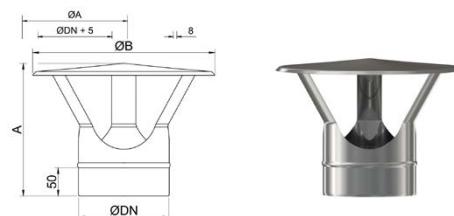

Terminal antirrevocante

Windproof ending parts / Chapeau anti-vent

Ø	EXOINOX SW 304		EXOINOX SW 316L		A	ØB	
	Referencia	€/Ud	Referencia	€/Ud			
120	AI120				255	220	1
130	AI130				250	255	1
150	AI150				305	270	1
180	AI180				300	295	1
200	AI200				330	330	1
250	AI250				335	380	1
300	AI300				335	450	1

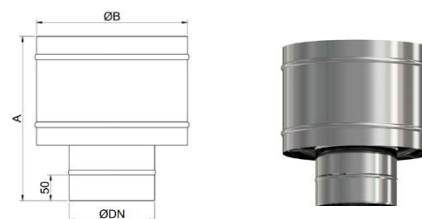

Terminal extractor

Aeolian ending part / Chapeau éolien

Ø	EXOINOX SW 304		EXOINOX SW 316L		A	ØB	
	Referencia	€/Ud	Referencia	€/Ud			
120	EI120				350	200	1
130	EI130				350	200	1
150	EI150				350	210	1
180	EI180				350	230	1
200	EI200				380	270	1
250	EI250				410	320	1
300	EI300				420	355	1



EXOINOX SW

Cubreaguas plomo de 5°/30°

5°/30° lead water cover / Solin plomb 5°/30°

Ø	EXOINOX SW 304		EXOINOX SW 316L		L	A	
	Referencia	€/Ud	Referencia	€/Ud			
130	CUI13030				600	175	1
150	CUI15030				600	190	1
180	CUI18030				800	235	1
200	CUI20030				800	235	1
250	CUI25030				800	255	1
300	CUI30030				1000	300	1

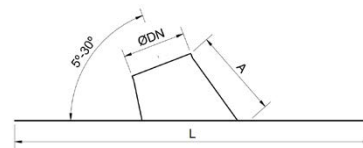

Cubreaguas plomo de 30°/45°

30°/45° lead water cover / Solin plomb 30°/45°

Ø	EXOINOX SW 304		EXOINOX SW 316L		L	A	
	Referencia	€/Ud	Referencia	€/Ud			
130	CUI13045				800	270	1
150	CUI15045				830	285	1
180	CUI18045				800	310	1
200	CUI20045				800	325	1
250	CUI25045				1000	375	1
300	CUI30045				1000	405	1

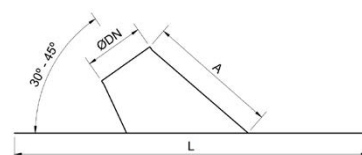

Junta de silicona H12

H12 silicon gasket / Joint silicone H12

Ø	EXOINOX SW 304		EXOINOX SW 316L		
	Referencia	€/Ud	Referencia	€/Ud	
120	PVJS120				1
130	PVJS130				1
150	PVJS150				1
180	PVJS180				1
200	PVJS200				1
250	PVJS250				1
300	PVJS300				1

